

YI

O

U

R

T

26

TANICHE

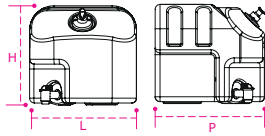

Polyethylene Water Tank 18 Lt.

Tanica Polietilene 18 Lt.

ARTICLE L H P KG

V40009 340 300 300 1,09 50

P V40009P 340 300 300 1,09 50

H6000 **Cliché for print Clichè per stampa**

i Recyclable polyethylene water tank 18 liters, available in black, with anti-crushing attaching point, soap dispenser supplied separately. Possibility to customise.

Tanica in polietilene riciclabile, capacità 18 litri, disponibile nei colori nero, con punti di fissaggio antisciacchiamento, con portasapone fornito separatamente. Possibilità di personalizzazione.

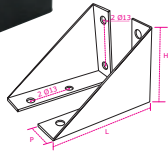

Pair of Universal Triangular Brackets

Coppia Staffe Universali Triangolari

ARTICLE L H P SP KG

S74000 170 120 40 30/10 1,00 2



TKcert RINA UNI EN ISO 15614-1:2012

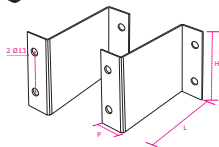

Pair of Universal Gullwing Brackets

Coppia Staffe Universali ad Ali di Gabbiano

ARTICLE L H P SP KG

S76000 160 130 40 30/10 1,47 2



TKcert RINA UNI EN ISO 15614-1:2012

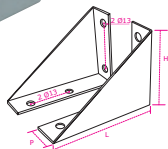
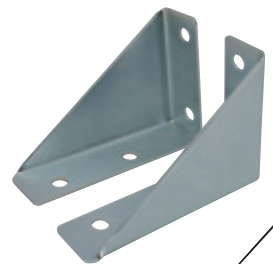

Pair of Galvanized Universal Triangular Brackets

Coppia Staffe Universali Zincate Triangolari

ARTICLE L H P SP KG

S75000 170 120 40 30/10 1,00 2



TKcert RINA UNI EN ISO 15614-1:2012

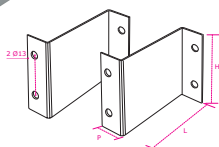
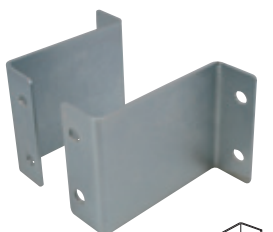

Pair of Galvanized Universal Gullwing Brackets

Coppia Staffe Universali Zincate ad Ali di Gabbiano

ARTICLE L H P SP KG

S77000 160 130 40 30/10 1,47 2



TKcert RINA UNI EN ISO 15614-1:2012

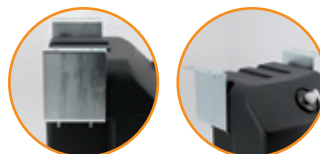



Polyethylene Water Tank 25 Lt.

Tanica Polietilene 25 Lt.

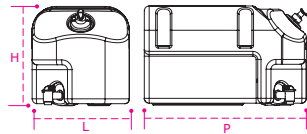

ARTICLE	L	H	P	KG	
V40010	300	306	500	2,50	50
P V40010P	300	306	500	2,50	50
H6000	Cliché for print Clichè per stampa				

i Recyclable polyethylene water tank 25 and 40 liters, available in black, with anti-crushing attaching point, soap dispenser supplied separately. Possibility to customise. *Tanica in polietilene riciclabile, capacità 25 e 40 litri, disponibile nei colori nero e neutro, con punti di fissaggio antischacciamento, con portasapone fornito separatamente. Possibilità di personalizzazione.*



Pair of Black Painted Universal Brackets

Coppia Staffe Universali Verniciate Nero

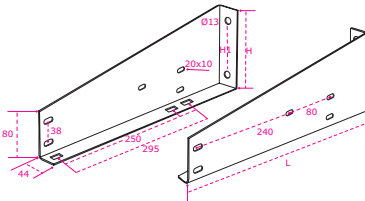

ARTICLE	L	H	H1	SP	KG	
S60000	455	155	105	30/10	3,60	2



TKcert RINA UNI EN ISO 15614-1:2012



Pair of Black Painted Universal Brackets

Coppia Staffe Universali Verniciate Nero

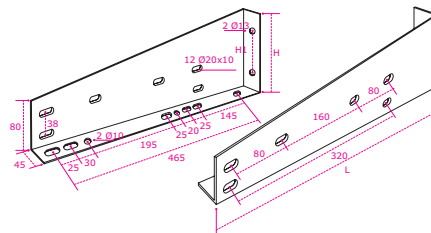

ARTICLE	L	H	H1	SP	KG	
S61000	530	200	105	30/10	5,05	2



TKcert RINA UNI EN ISO 15614-1:2012

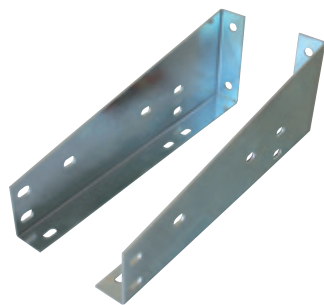

Pair of Galvanized Universal Brackets

Coppia Staffe Universali Zincate

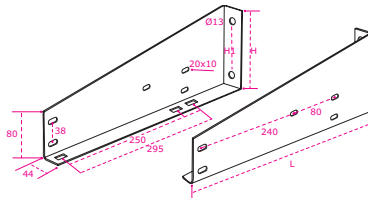

ARTICLE	L	H	H1	SP	KG	
S64000	455	155	105	30/10	3,60	2



TKcert RINA UNI EN ISO 15614-1:2012

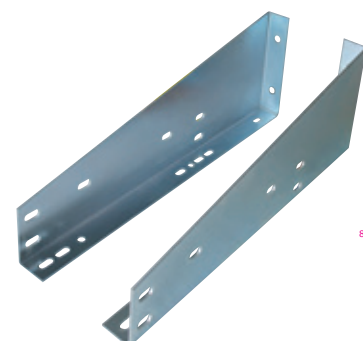

Pair of Galvanized Universal Brackets

Coppia Staffe Universali Zincate

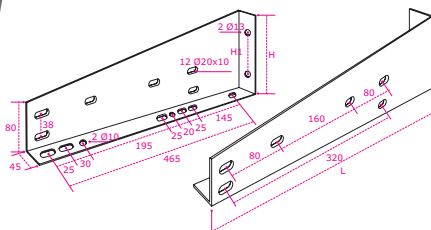

ARTICLE	L	H	H1	SP	KG	
S65000	530	200	105	30/10	4,64	2



TKcert RINA UNI EN ISO 15614-1:2012

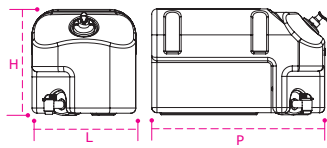

Polyethylene Water Tank 40 Lt.

Tanica Polietilene 40 Lt.

ARTICLE	L	H	P	KG	
V40011 ^{40 Liters} 40 Litri	360	360	495	3,00	30
P V40011P	360	360	495	3,00	30
H6000	Cliché for print Clichè per stampa				

i Recyclable polyethylene water tank 40 liters, available in black, with anti-crushing attaching point, soap dispenser supplied separately. Possibility to customise. *Tanica in polietilene riciclabile, capacità 40 litri, disponibile nei colori nero e neutro, con punti di fissaggio antischiacciamento, con portasapone fornito separatamente. Possibilità di personalizzazione.*



Pair of Black Painted Universal Brackets

Coppia Staffe Universali Verniciate Nero

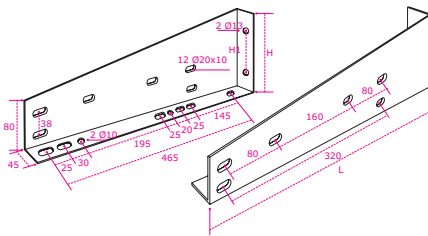

ARTICLE	L	H	H1	SP	KG	
S61000	530	200	105	30/10	5,05	2



TKcert RINA UNI EN ISO 15614-1:2012

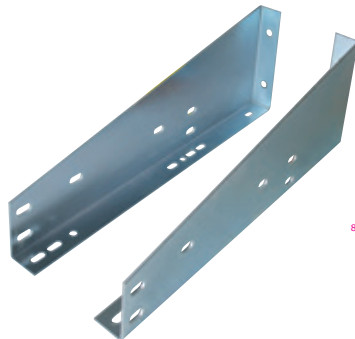

Pair of Galvanized Universal Brackets

Coppia Staffe Universali Zincate

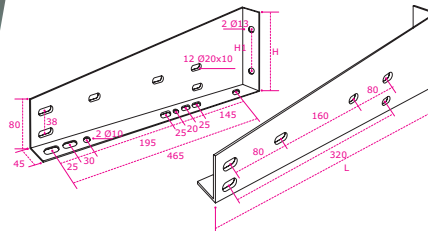

ARTICLE	L	H	H1	SP	KG	
S65000	530	200	105	30/10	4,64	2



TKcert RINA UNI EN ISO 15614-1:2012





White PVC Water Tank 30 Lt. *Tanica in Pvc Bianca 30 Lt.*

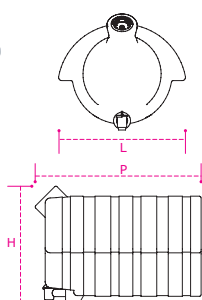

ARTICLE		L	H	P	KG	
V20011	30 Liters 30 Litri	390	350	500	2,80	8
P V20011P		390	350	500	2,80	8

i Recyclable polyethylene water tank 30 liters, available in black and white, with anti-crushing attaching point, soap dispenser supplied separately. Possibility to customise.
Tanica in polietilene riciclabile, capacità 30 litri, disponibile nei colori nero e bianco, con punti di fissaggio antischiacciamento, con portasapone fornito separatamente. Possibilità di personalizzazione.



Pair of Black Painted Universal Brackets

Coppia Staffe Universali Verniciate Nero

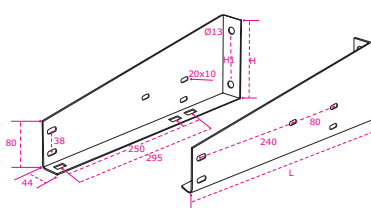

ARTICLE	L	H	H1	SP	KG	
S60000	455	155	105	30/10	3,60	2



TKcert RINA UNI EN ISO 15614-1:2012



Pair of Black Painted Universal Brackets

Coppia Staffe Universali Verniciate Nero

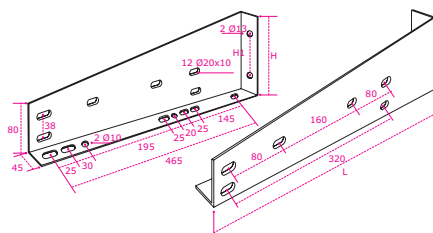

ARTICLE	L	H	H1	SP	KG	
S61000	530	200	105	30/10	5,65	2



TKcert RINA UNI EN ISO 15614-1:2012

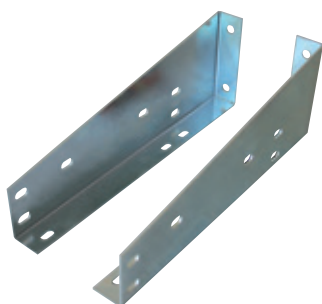

Pair of Galvanized Universal Brackets

Coppia Staffe Universali Zincate

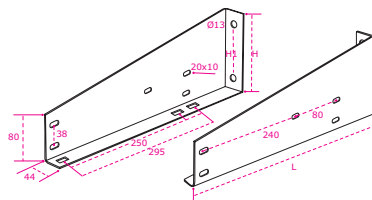

ARTICLE	L	H	H1	SP	KG	
S64000	455	155	105	30/10	3,60	2



TKcert RINA UNI EN ISO 15614-1:2012



Pair of Galvanized Universal Brackets

Coppia Staffe Universali Zincate

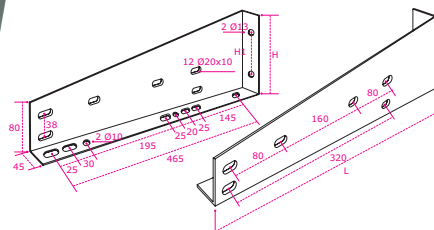

ARTICLE	L	H	H1	SP	KG	
S65000	530	200	105	30/10	4,64	2



TKcert RINA UNI EN ISO 15614-1:2012

Black PVC Water Tank 30 Lt. *Tanica in Pvc Nera 30 Lt.*

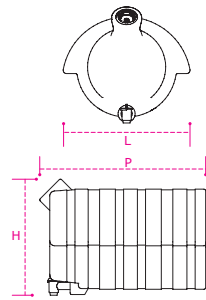

ARTICLE		L	H	P	KG	
V20010	30 Liters 30 Litri	390	350	500	2,80	8
P V20010P		390	350	500	2,80	8

i Black recyclable polyethylene water tank 30 liters, available in black and white, with anti-crushing attaching point, soap dispenser supplied separately.
Possibility to customise.
Tanica nera in polietilene riciclabile, capacità 30 litri, disponibile nei colori nero e bianco, con punti di fissaggio antischiacciamento, con portasapone fornito separatamente. Possibilità di personalizzazione.



Pair of Black Painted Universal Brackets

Coppia Staffe Universali Verniciate Nero

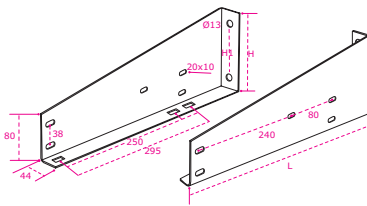

ARTICLE	L	H	H1	SP	KG	
S60000	455	155	105	30/10	3,60	2



TKcert RINA UNI EN ISO 15614-1:2012



Pair of Black Painted Universal Brackets

Coppia Staffe Universali Verniciate Nero

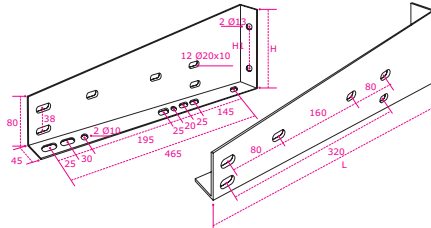

ARTICLE	L	H	H1	SP	KG	
S61000	530	200	105	30/10	5,05	2



TKcert RINA UNI EN ISO 15614-1:2012



Pair of Galvanized Universal Brackets

Coppia Staffe Universali Zincate

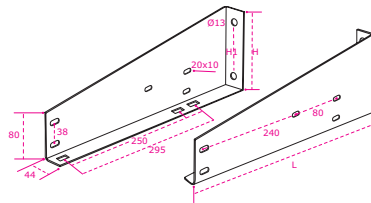

ARTICLE	L	H	H1	SP	KG	
S64000	455	155	105	30/10	3,60	2



TKcert RINA UNI EN ISO 15614-1:2012

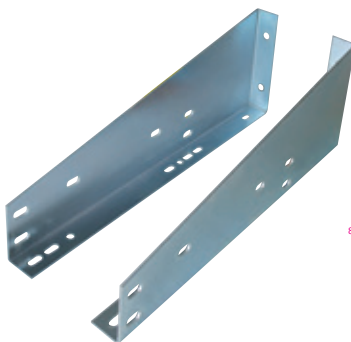

Pair of Galvanized Universal Brackets

Coppia Staffe Universali Zincate

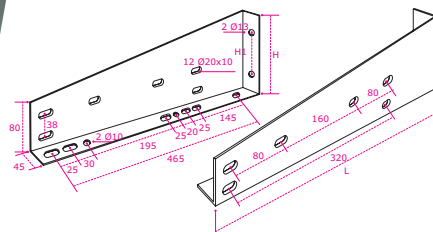

ARTICLE	L	H	H1	SP	KG	
S65000	530	200	105	30/10	4,64	2



TKcert RINA UNI EN ISO 15614-1:2012



White PVC Water Tank 50 Lt. *Tanica in Pvc Bianca 50 Lt.*

ARTICLE	L	H	P	KG	
V2001150 ^{50 Liters} 50 Litri	473	422	533	3,80	1
P V2001150P	473	422	533	3,80	1

i Recyclable polyethylene water tank 50 liters, available in black and white, with anti-crushing attaching point, soap dispenser supplied separately. Possibility to customise.

Tanica in polietilene riciclabile, capacità 50 litri, disponibile nei colori nero e bianco, con punti di fissaggio antischiacciamento, con portasapone fornito separatamente. Possibilità di personalizzazione.

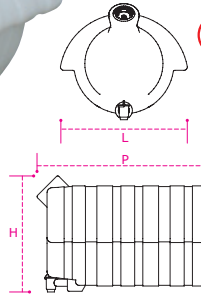

Pair of Galvanized Universal Brackets

Coppia Staffe Universali Zincate

ARTICLE	L	H	H1	SP	KG	
S65000	530	200	105	30/10	4,64	2

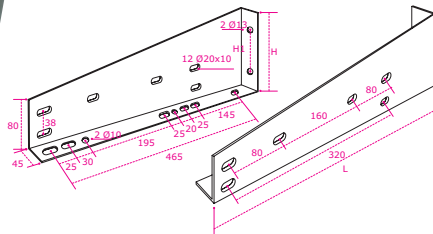

TKcert RINA UNI EN ISO 15614-1:2012



Black PVC Water Tank 50 Lt. *Tanica in Pvc Nera 50 Lt.*

ARTICLE	L	H	P	KG	
V2001050 ^{50 Liters} 50 Litri	473	422	533	3,80	1
P V2001050P	473	422	533	3,80	1

i Recyclable polyethylene water tank 50 liters, available in black and white, with anti-crushing attaching point, soap dispenser supplied separately. Possibility to customise.

Tanica in polietilene riciclabile, capacità 50 litri, disponibile nei colori nero e bianco, con punti di fissaggio antischiacciamento, con portasapone fornito separatamente. Possibilità di personalizzazione.

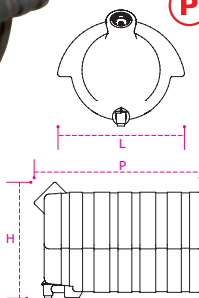

Pair of Black Painted Universal Brackets

Coppia Staffe Universali Verniciate Nero

ARTICLE	L	H	H1	SP	KG	
S61000	530	200	105	30/10	5,05	2

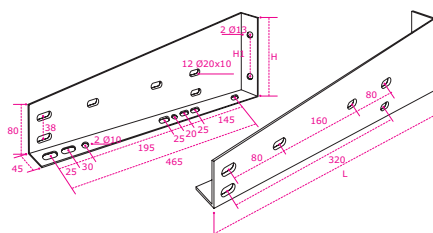

TKcert RINA UNI EN ISO 15614-1:2012

Plastic Water Tank 25 Lt. with Galvanized Support

Tanica Acqua 25 Lt. con Supporto Zincato



ORIGINAL

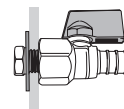

ARTICLE	L	H	P	KG		
T962/Z	225	450	600	5,60	1	40

TKcert RINA UNI EN ISO 15614-1:2012

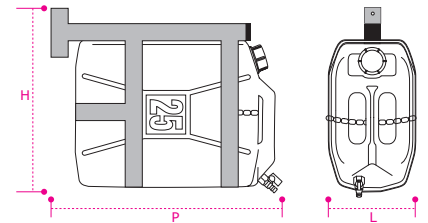

Plastic Water Tank 10 Lt. with Galvanized Support

Tanica Acqua 10 Lt. con Supporto Zincato

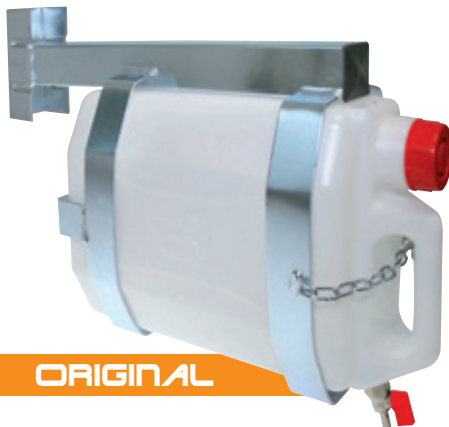

ORIGINAL

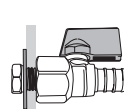

ARTICLE	L	H	P	KG		
T966/Z	175	380	480	4,20	1	50

TKcert RINA UNI EN ISO 15614-1:2012

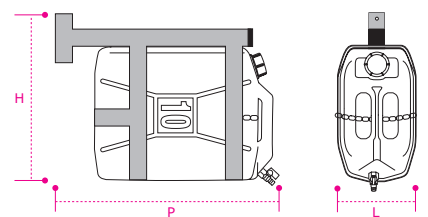

FULLOPTIONAL NEW MODEL

COMPONENTS "ORIGINAL":

T962/Z

Plastic Water Tank 25 Lt. with Galvanized Support
Tanica Acqua 25 Lt. con Supporto Zincato

T966/Z

Plastic Water Tank 10 Lt. with Galvanized Support
Tanica Acqua 10 Lt. con Supporto Zincato

111P

Anti-theft Cap for Water Tank with Double Keys
Tappo Antifurto per Tanica Acqua con Doppia Chiave

T998S

Kit Soap Dispenser with Antibacterial
Soap 250 ml. Vertical Bracket
Kit Portasapone con Sapone Antibatterico 250 ml. Staffa Verticale

R70127

Rubber Pipe with Wrappers
Tube Cristallo con Fascetta Bifilare per Rubinetto 1/4 Ø11



Plastic Water Tank 25 Lt. with Galvanized Support and Fixing Feet

Tanica Acqua 25 Lt. con Supporto Zincato e 4 Piedini

ARTICLE	L	H	P	i L	i P	KG		
T973Z	225	410	490	215	275	4,85	1	32



TRACTOR



TKcert RINA UNI EN ISO 15614-1:2012

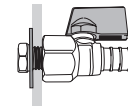
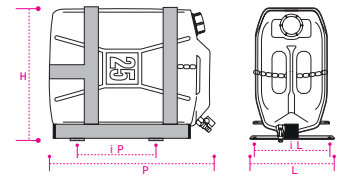

Plastic Water Tank 10 Lt. with Galvanized Support and Fixing Feet

Tanica Acqua 10 Lt. con Supporto Zincato e 4 Piedini

ARTICLE	L	H	P	i L	i P	KG		
T974Z	200	300	350	175	200	3,10	1	50



TRACTOR



TKcert RINA UNI EN ISO 15614-1:2012

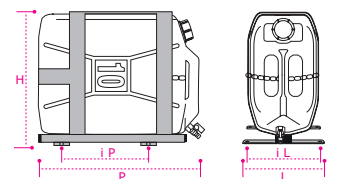

FULLOPTIONAL NEW MODEL

COMPONENTS "TRACTOR":

T973Z

Plastic Water Tank 25 Lt. with Galvanized Support and Fixing Feet
Tanica Acqua 25 Lt. con Supporto Zincato e 4 Piedini

T974Z

Plastic Water Tank 10 Lt. with Galvanized Support and Fixing Feet
Tanica Acqua 10 Lt. con Supporto Zincato e 4 Piedini

111P

Anti-theft Cap for Water Tank with Double Keys
Tappo Antifurto per Tanica Acqua con Doppia Chiave

T998S

Kit Soap Dispenser with Antibacterial
Soap 250 ml. Vertical Bracket
Kit Portasapone con Sapone Antibatterico 250 ml. Staffa Verticale

R70126

Shock Absorbers Kit
Kit Ammortizzatori con Viti TGE 8x16

R70127

Rubber Pipe with Wrappers
Tubo Cristallo con Fascetta Bifilare per Rubinetto 1/4 Ø11



Plastic Water Tank 10 Lt. with Galvanized Support and Lateral Fixing

Tanica Acqua 10 Lt. con Supporto Zincato e Attacco Laterale



LATERAL

ARTICLE	L	H	P	i H	i P	KG		
T979Z	190	285	350	235	200	3,90	1	50

TKcertRINA UNI EN ISO 15614-1:2012

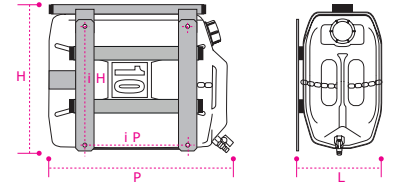
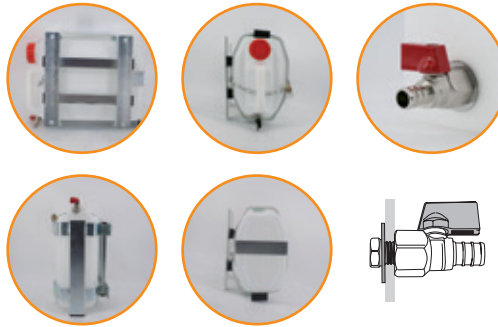

Plastic Water Tank 10 Lt. with Galvanized Support for Iveco S-Way

Tanica Acqua 10 Lt. con Supporto Zincato per Iveco S-Way



ORIGINAL



ARTICLE	L	H	P	KG		
T986Z	165	315	350	3,10	1	40

TKcertRINA UNI EN ISO 15614-1:2012

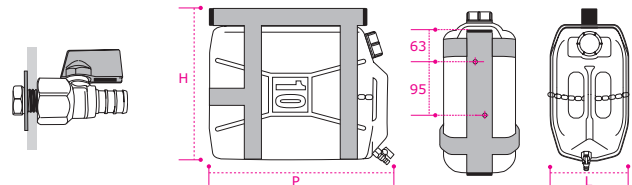

Plastic Water Tank 10 Lt. With Galvanized Support for Piaggio PORTER NP6

Tanica Acqua 10 Lt. con Supporto Zincato per Piaggio PORTER NP6



ORIGINAL



ARTICLE	L	H	P	KG		
T988Z	190	320	380	3,70	1	24

TKcertRINA UNI EN ISO 15614-1:2012

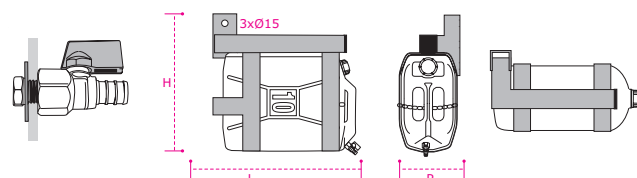



VERTICAL

Plastic Water Tank 10 Lt. with Vertical Galvanized Support

Tanica Acqua 10 Lt. con Supporto Zincato Verticale

ARTICLE	L	H	P	KG		
T967Z	175	355	290	2,60	1	50

TKcert RINA UNI EN ISO 15614-1:2012

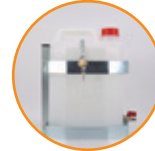
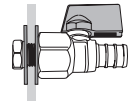
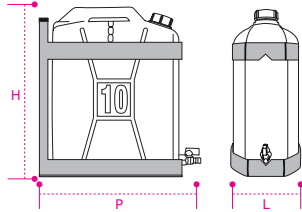

VERTICAL

Plastic Water Tank 25 Lt. with Vertical Galvanized Support

Tanica Acqua 25 Lt. con Supporto Zincato Verticale

ARTICLE	L	H	P	KG		
T964Z	225	490	420	4,30	1	32

TKcert RINA UNI EN ISO 15614-1:2012

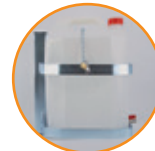
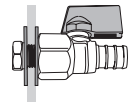
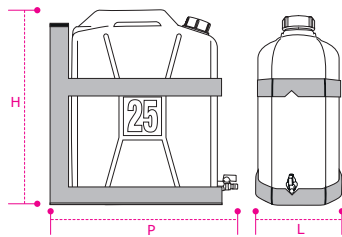

VERTICAL

Plastic Water Tank 25 Lt. with Vertical Galvanized Support

Tanica Acqua 25 Lt. con Supporto Zincato Verticale

ARTICLE	L	H	P	KG		
T965Z	225	490	580	5,60	1	24

TKcert RINA UNI EN ISO 15614-1:2012

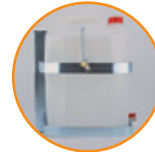
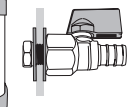
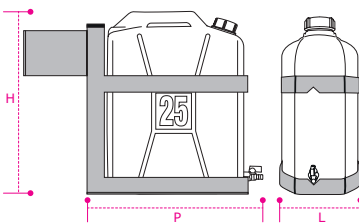

FULL OPTIONAL **NEW MODEL**

COMPONENTS "VERTICAL":

T967Z

Plastic Water Tank 10 Lt. with Vertical Galvanized Support
Tanica Acqua 10 Lt. con Supporto Zincato Verticale

T964Z - T965Z

Plastic Water Tank 25 Lt. with Vertical Galvanized Support
Tanica Acqua 25 Lt. con Supporto Zincato Verticale

111P

Anti-theft Cap for Water Tank with Double Keys
Tappo Antifurto per Tanica Acqua con Doppia Chiave

T998S

Kit Soap Dispenser with Antibacterial Soap 250 ml. Horizontal Bracket
Kit Portasapone con Sapone

Antibatterico 250 ml. Staffa Orizzontale

R70126

Shock Absorbers Kit
Kit Ammortizzatori con Viti TGE 8x16

R70127

Rubber Pipe with Wrappers
Tubo Cristallo con Fascetta Bifilare per Rubinetto 1/4 Ø11



Plastic Water Tank 10 Lt. with Horizontal Galvanized Curved Left Support

Tanica Acqua 10 Lt. con Supporto Orizzontale Curvato Sinistro Lato Guida



CURVED



ARTICLE	L	H	P	P1	KG		
T985Z	560	360	310	180	4,20	1	24

TKcert RINA UNI EN ISO 15614-1:2012

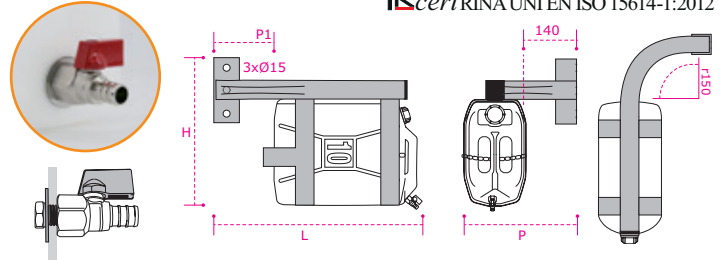

Plastic Water Tank 25 Lt. with Horizontal Galvanized Curved Support

Tanica Acqua 25 Lt. con Supporto Curvato Zincato Orizzontale



CURVED



ARTICLE	L	H	P	P1	KG		
T987Z	660	420	380	170	5,70	1	24

TKcert RINA UNI EN ISO 15614-1:2012

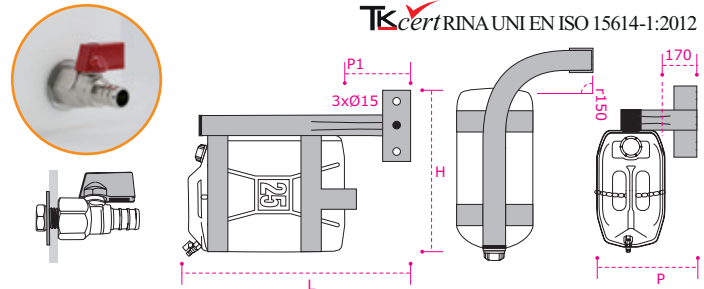

Plastic Water Tank 25 Lt. with Vertical Galvanized Curved Support

Tanica Acqua 25 Lt. con Supporto Curvato Zincato Verticale



CURVED



ARTICLE	L	H	P	P1	KG		
T982Z	225	580	600	210	5,70	1	24

TKcert RINA UNI EN ISO 15614-1:2012

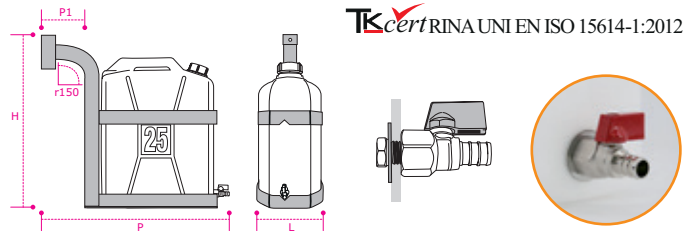

FULLOPTIONAL

COMPONENTS "CURVED":

T985Z
Plastic Water Tank 10 Lt. with Horizontal Galvanized Curved Left Support
Tanica Acqua 10 Lt. con Supporto Orizzontale Curvato Sinistro Lato Guida

T987Z
Plastic Water Tank 25 Lt. with Horizontal Galvanized Curved Support
Tanica Acqua 25 Lt. con

Supporto Curvato Zincato Orizzontale

T982Z
Plastic Water Tank 25 Lt
111P

Anti-theft Cap for Water Tank with Double Keys
Tappo Antifurto per Tanica Acqua con Doppia Chiave

T998S
Kit Soap Dispenser with Antibacterial Soap 250 ml.

Horizontal Bracket
Kit Portasapone con Sapone Antibatterico 250 ml. Staffa Orizzontale

R70126
Shock Absorbers Kit
Kit Ammortizzatori con Viti TGE 8x16

R70127
Rubber Pipe with Wrappers
Tube Cristallo con Fascetta Bifilare per Rubinetto 1/4 Ø11

NEW MODEL



Plastic Water Tank 10 Lt. with Faucet

Tanica Nuda 10 Lt. con Rubinetto



ARTICLE	L	H	P	KG		
T969	156	245	370	0,57	1	60

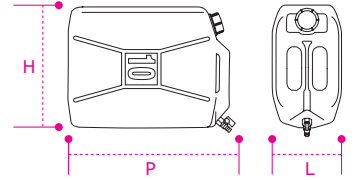
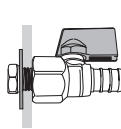

Plastic Water Tank 15 Lt. with Faucet

Tanica Nuda 15 Lt. con Rubinetto



ARTICLE	L	H	P	KG		
T984	176	286	421	1,43	1	60

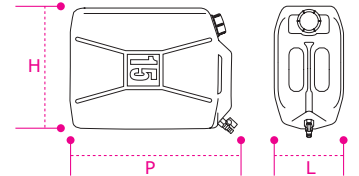
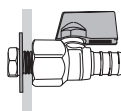

Plastic Water Tank 20 Lt. with Faucet

Tanica Nuda 20 Lt. con Rubinetto



ARTICLE	L	H	P	KG		
T972	190	315	440	0,89	1	60

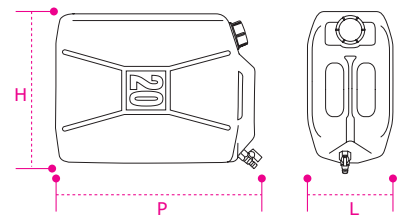
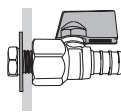

Plastic Water Tank 25 Lt. with Faucet

Tanica Nuda 25 Lt. con Rubinetto



ARTICLE	L	H	P	KG		
T961	215	340	480	1,20	1	60

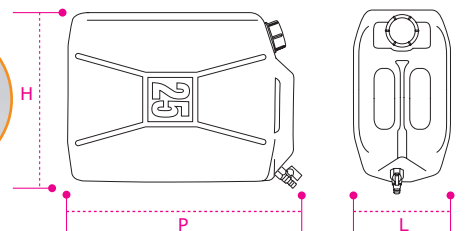
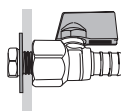



Vertical Plastic Water Tank 10 Lt. with Faucet

Tanica Verticale 10 Lt. Nuda con Rubinetto

ARTICLE	L	H	P	KG		
T970	156	360	285	0,57	1	60

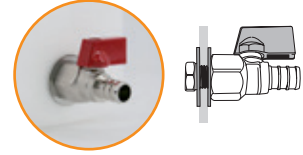
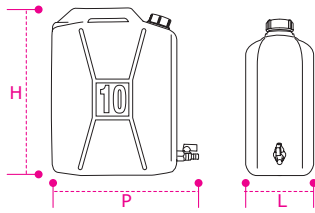

Vertical Plastic Water Tank 15 Lt. with Faucet

Tanica Verticale 15 Lt. Nuda con Rubinetto

ARTICLE	L	H	P	KG		
T983	176	416	331	1,43	1	60

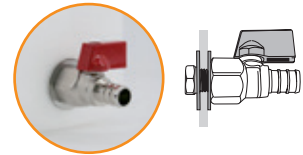
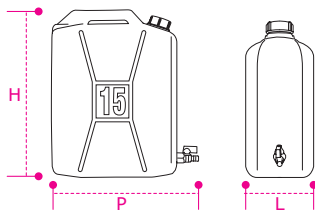

Vertical Plastic Water Tank 20 Lt. with Faucet

Tanica Verticale 20 Lt. Nuda con Rubinetto

ARTICLE	L	H	P	KG		
T971	190	440	360	0,89	1	60

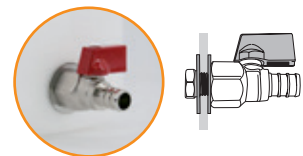
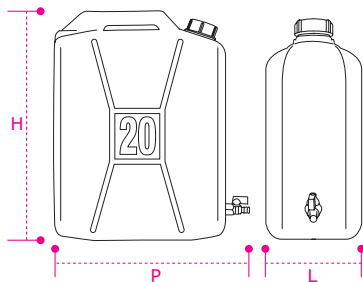

Vertical Plastic Water Tank 25 Lt. with Faucet

Tanica Verticale 25 Lt. Nuda con Rubinetto

ARTICLE	L	H	P	KG		
T963	215	480	380	1,10	1	60

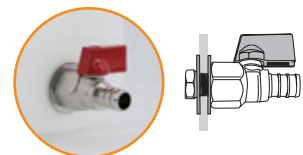
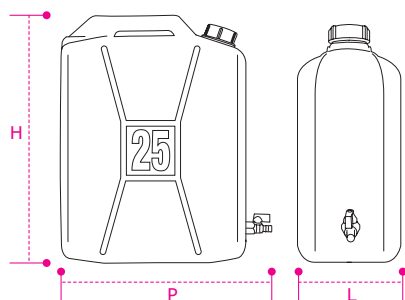



**Vertical Plastic Water Tank 10 Lt.
without Faucet Food Safety Certification**

Tanica Verticale 10 Lt. Nuda senza Rubinetto ed Etichetta Certificata per Alimenti

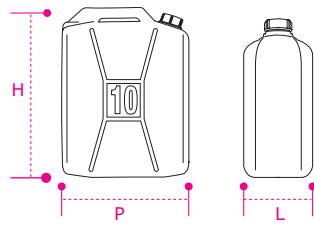

ARTICLE	L	H	P	KG		
CL10	156	360	240	0,45	1	60



**Vertical Plastic Water Tank 15 Lt.
without Faucet Food Safety Certification**

Tanica Verticale 15 Lt. Nuda senza Rubinetto ed Etichetta Certificata per Alimenti

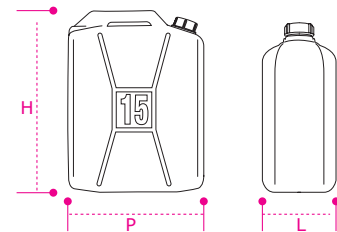

ARTICLE	L	H	P	KG		
CL15	176	416	286	0,60	1	60



**Vertical Plastic Water Tank 20 Lt.
without Faucet Food Safety Certification**

Tanica Verticale 20 Lt. Nuda senza Rubinetto ed Etichetta Certificata per Alimenti

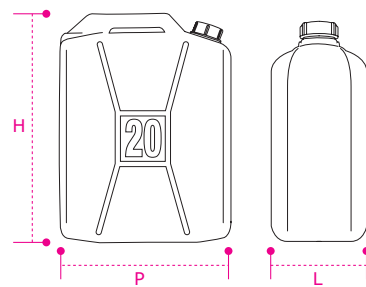

ARTICLE	L	H	P	KG		
CL20	190	440	315	0,75	1	60



**Vertical Plastic Water Tank 25 Lt.
without Faucet Food Safety Certification**

Tanica Verticale 25 Lt. Nuda senza Rubinetto ed Etichetta Certificata per Alimenti

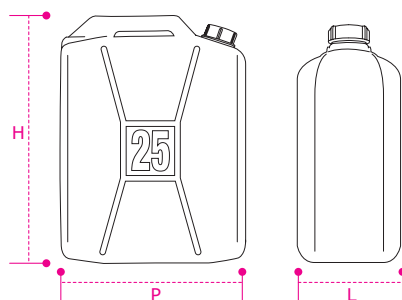

ARTICLE	L	H	P	KG		
CL25	215	480	335	0,80	1	60



Galvanized Support for Water Tank 25 Lt.

Supporto Zincato per Tanica Acqua 25 Lt.

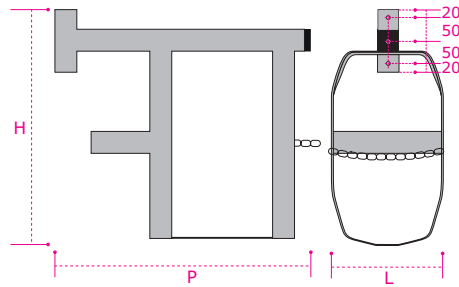

ARTICLE	L	H	P	KG	
T960	225	410	500	4,10	1

TKcert RINA UNI EN ISO 15614-1:2012

i Complete of pvc cap, chain and padlock.
Completo di tappo in pvc, catena e lucchetto.

Galvanized Support for Water Tank 25 Lt. with Fixing Feet

Supporto Zincato per Tanica Acqua 25 Lt. con 4 Piedini

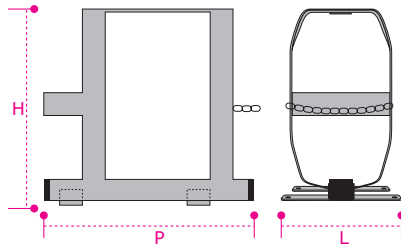

ARTICLE	L	H	P	i L	i P	KG	
T975	225	410	395	215	275	3,85	1

TKcert RINA UNI EN ISO 15614-1:2012

i Complete of pvc cap, chain and padlock.
Completo di tappo in pvc, catena e lucchetto.



Vertical Galvanized Support for Water Tank 25 Lt.

Supporto Zincato Verticale per Tanica Acqua 25 Lt.

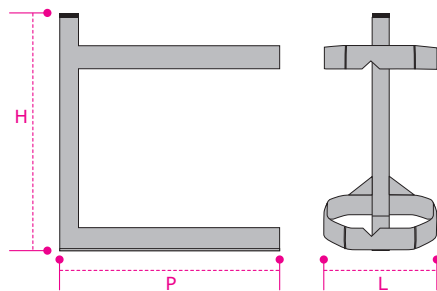

ARTICLE	L	H	P	KG	
T978	225	440	400	3,55	1

TKcert RINA UNI EN ISO 15614-1:2012

i Complete of pvc cap, chain and padlock.
Completo di tappo in pvc, catena e lucchetto.



Vertical Galvanized Support for Water Tank with Bracket 25 Lt.

Supporto Zincato Verticale per Tanica Acqua 25 Lt. con Staffa di Fissaggio

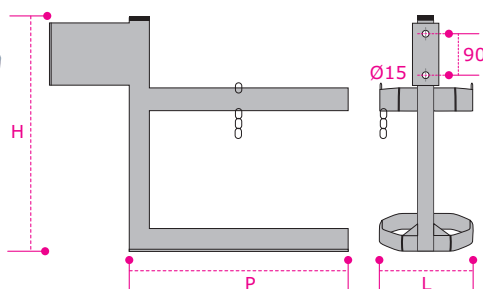

ARTICLE	L	H	P	KG	
T981	225	470	555	4,65	1

TKcert RINA UNI EN ISO 15614-1:2012

i Complete of pvc cap, chain and padlock.
Completo di tappo in pvc, catena e lucchetto.



Galvanized Support for Water Tank 10 Lt.

Supporto Zincato per Tanica Acqua 10 Lt.

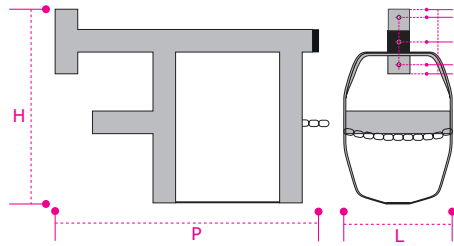

ARTICLE	L	H	P	KG	
T964	175	315	440	3,25	1

TKcert RINA UNI EN ISO 15614-1:2012

Complete of pvc cap, chain and padlock.
Completo di tappo in pvc, catena e lucchetto.

Galvanized Support for Water Tank 10 Lt. with Fixing Feet

Supporto Zincato per Tanica Acqua 10 Lt. con 4 Piedini

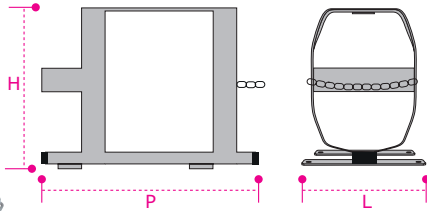

ARTICLE	L	H	P	i L	i P	KG	
T974	200	295	295	175	200	2,60	1

TKcert RINA UNI EN ISO 15614-1:2012

Complete of pvc cap, chain and padlock.
Completo di tappo in pvc, catena e lucchetto.



Vertical Galvanized Support for Water Tank 10 Lt.

Supporto Zincato Verticale per Tanica Acqua 10 Lt.

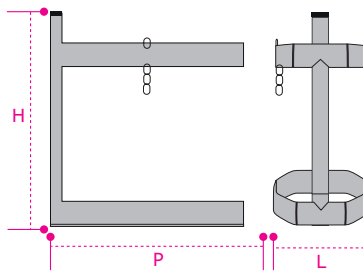

ARTICLE	L	H	P	KG	
T976	175	300	290	2,10	1

TKcert RINA UNI EN ISO 15614-1:2012

Complete of pvc cap, chain and padlock.
Completo di tappo in pvc, catena e lucchetto.

Galvanized Support for Water Tank 10 Lt. with Lateral Fixing

Supporto Zincato per Tanica Acqua 10 Lt. con Attacco Laterale

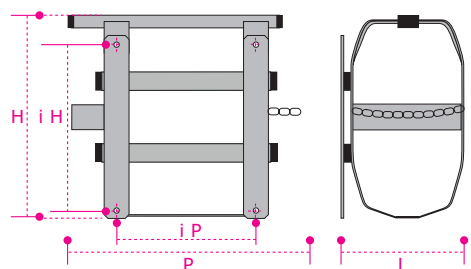

ARTICLE	L	H	P	i H	i P	KG	
T977	190	285	290	235	200	3,40	1

TKcert RINA UNI EN ISO 15614-1:2012

Complete of pvc cap, chain and padlock.
Completo di tappo in pvc, catena e lucchetto.

Threaded Support for Soap Dispenser Horizontal Bracket

Supporto Filettato per Portasapone Staffa Orizzontale

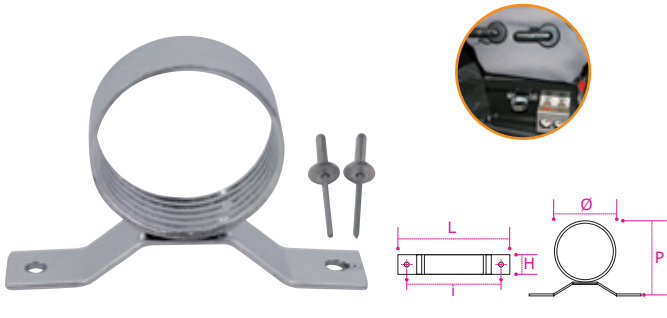

ARTICLE	L	H	P	D	i	KG	
T999	114	20	80	60	96	0,08	1

Threaded Support for Soap Dispenser Vertical Bracket

Supporto Filettato per Portasapone Staffa Verticale

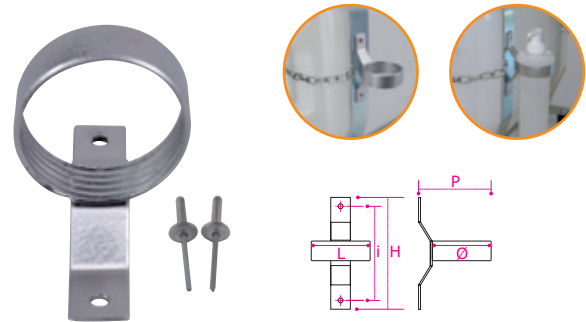

ARTICLE	L	H	P	D	i	KG	
T998	60	114	80	60	96	0,08	1

Universal PVC Soap Dispenser

Portasapone Universale in Tpl



ARTICLE	H	D	KG	
V10026	200	56	0,07	1

Rubber Pipe with Wrappers

Tube Cristallo e Fascetta Bifilare per Rubinetto 1/4 Ø11



ARTICLE	L	D	KG	
R70127	600	14	0,06	1

Shock Absorbers Kit

Kit Ammortizzatori con Viti TGE 8x16

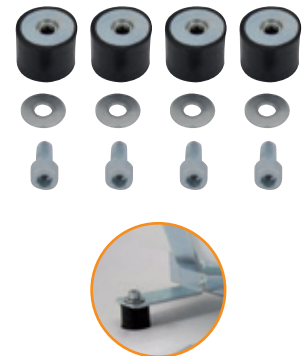

ARTICLE	H	D	KG	
R70126	25	30	0,25	1

Faucet 1/4

Rubinetto Dritto Passo 1/4



ARTICLE	PA	L	D	KG	
V20018	1/4	45	11	0,06	1

PVC Cap

Tappo per Taniche Inox BA a Tubo



ARTICLE	H	D	KG	
112	15	40	0,017	1

PVC Cap

Tappo per Taniche PVC



ARTICLE	H	D	KG	
111	30	60	0,017	1

Flowered Stainless Steel Water Tank 12 Lt.

Tanica Acciaio Inox Fiore 12 Lt.

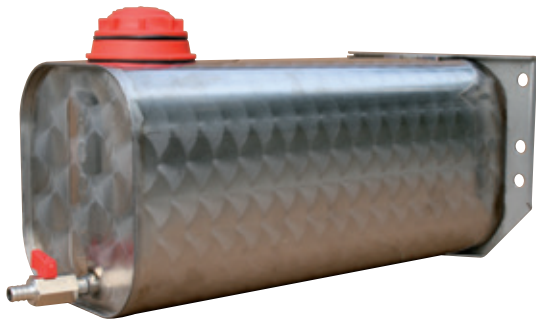

ARTICLE	L	H	P	KG	
V10020	175	180	450	3,30	1

i Soap dispenser and support bracket are supplied separately.
Portasapone e staffa supporto posteriore vengono vendute separatamente.

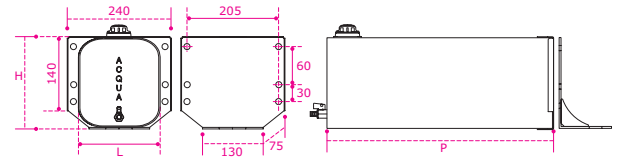

Flowered Stainless Steel Water Tank 12 Lt.

Tanica Acciaio Inox Fiore 12 Lt. Fissaggio con Piedini



ARTICLE	L	H	P	i	KG	
V10037	175	180	410	310	3,30	1

i Soap dispenser supplied separately.
Portasapone fornito separatamente.

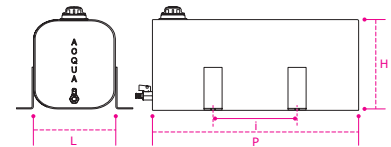

Flowered Stainless Steel Water Tank 12 Lt.

Tanica Inox Fiore 12 Lt. con Attacchi Laterali ad Ala di Gabbiano

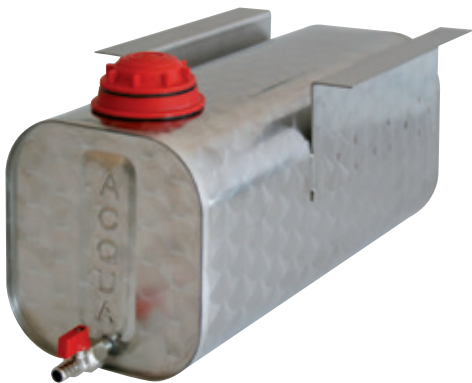

ARTICLE	L	H	P	KG	
V10028	170	180	410	3,40	1

i Soap dispenser supplied separately.
Portasapone fornito separatamente.

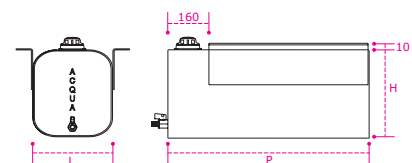

Flowered Stainless Steel Water Tank 8 Lt.

Tanica Acciaio Inox Fiore Piccola 8 Lt.



ARTICLE	L	H	P	KG	
V10035	170	180	250	2,20	1

i Soap dispenser supplied separately.
Portasapone fornito separatamente.

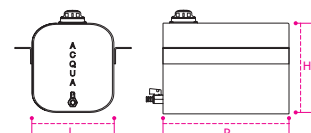



Flowered Stainless Steel Water Tank 25 Lt.

Tanica Acciaio Inox Fiore 25 Lt.



ARTICLE	L	H	P	KG	
V10021	175	400	450	5,70	1

i Soap dispenser supplied separately.
Portasapone fornito separatamente.

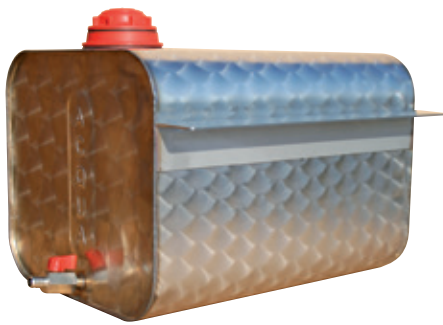
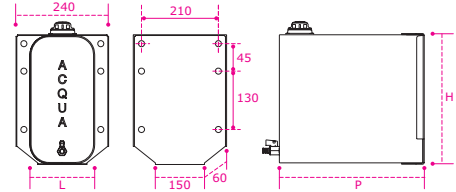

Flowered Stainless Steel Water Tank 25 Lt.

Tanica Acciaio Inox Fiore 25 Lt. con Attacchi Laterali ad Ala di Gabbiano



ARTICLE	L	H	P	KG	
V10022	285	295	420	4,00	1

i Soap dispenser supplied separately.
Portasapone fornito separatamente.

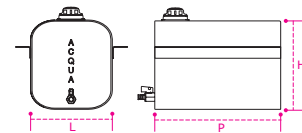

Flowered Stainless Steel Water Tank 50 Lt.

Tanica Acqua Inox Fiore 50 Lt. Attacco Laterale



ARTICLE	L	H	P	i	KG	
V1002250	285	255	700	315	11,20	1

i Soap dispenser supplied separately.
Portasapone fornito separatamente.

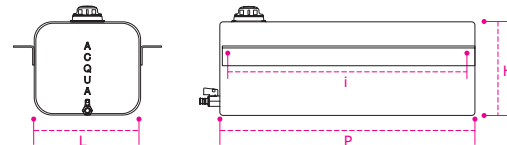

Flowered Stainless Steel Water Tank 25 Lt.

Tanica Acciaio Inox Fiore 25 Lt. Fissaggio con Piedini



ARTICLE	L	H	P	i	KG	
V10039	175	400	410	310	5,70	1

i Soap dispenser supplied separately.
Portasapone fornito separatamente.

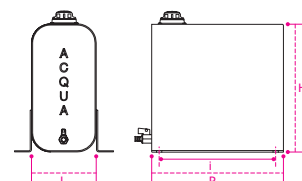

Flowered Stainless Steel Water Tank with Support 25 lt.

Tanica Inox Fiore completa di Cestello Estraibile 25 lt.

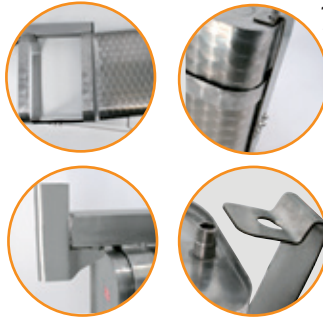

ARTICLE	L	H	P	KG	
V10066	175	400	450	5,70	1

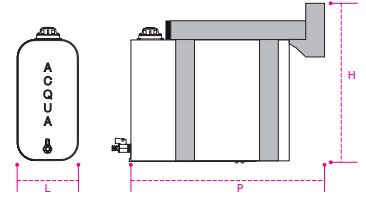

Flowered Stainless Steel Water Tank 25 lt.

Tanica Nuda Inox Fiore 25 lt.



ARTICLE	L	H	P	KG	
V10057	175	400	450	5,70	1

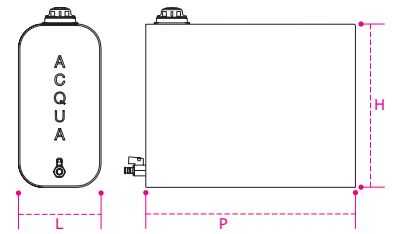

Stainless Steel BA Mirror Water Tank 12 Lt.

Tanica Acciaio Inox 304 BA Specchiato 12 Lt.

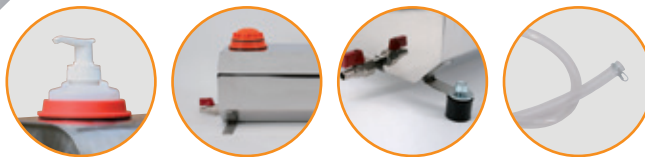
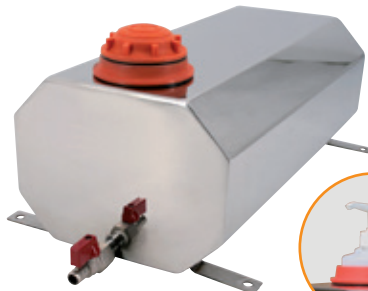

ARTICLE	L	H	P	iL	iP	KG	
V10078	255	150	400	235	260	4,15	1

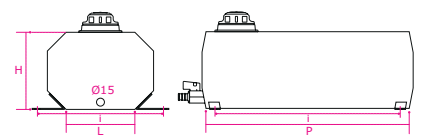

Stainless Steel BA Mirror Water Tank Under Cabin for Scania New Generation 15 lt.

Tanica Acqua Acciaio Inox BA Specchiato Sottocabina per Scania New Generation 15 lt.

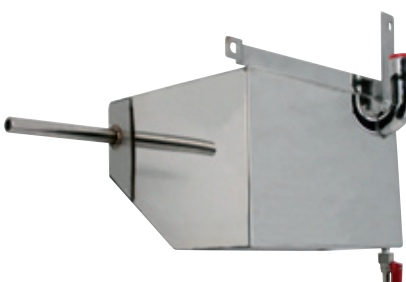

ARTICLE	L	H	P	KG	
V10082	330	220	200	6,75	1

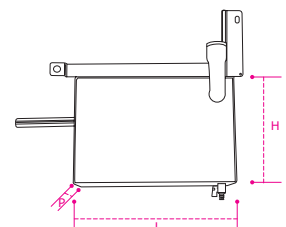

Stainless Steel BA Tubular Water Tank 12 Lt. for SCANIA NEW GENERATION

Tanica Acqua a Tubo Inox BA 12Lt. per SCANIA NEW GENERATION

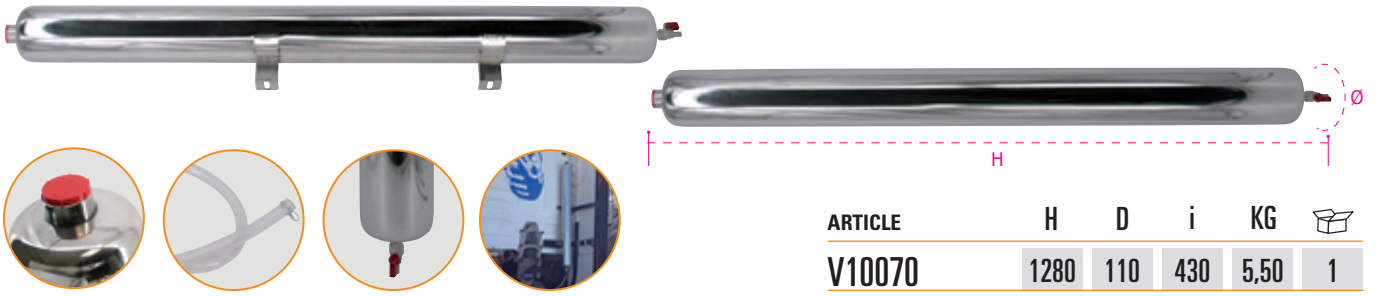

ARTICLE	H	D	i	KG	
V10070	1280	110	430	5,50	1

Stainless Steel BA Tubular Water Tank 12 Lt. for SCANIA R2/R3

Tanica Acqua a Tubo Inox BA 12 Lt. per SCANIA R2/R3

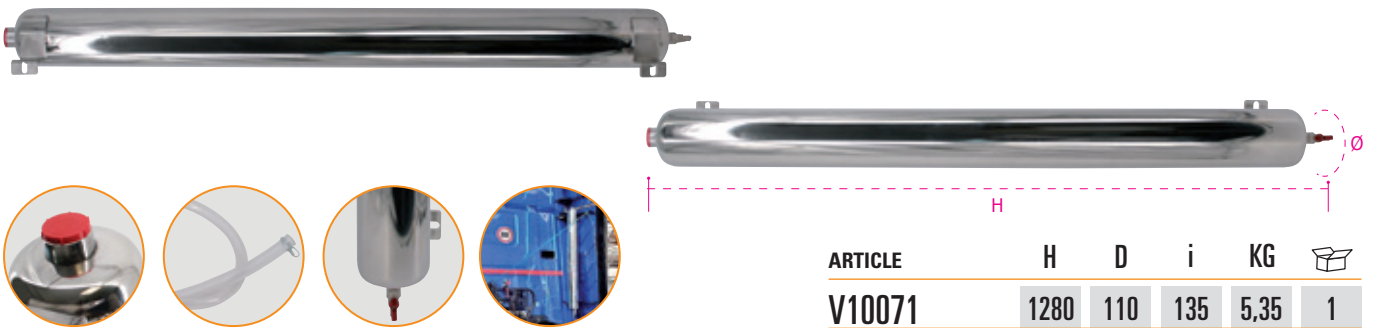

ARTICLE	H	D	i	KG	
V10071	1280	110	135	5,35	1

Stainless Steel BA Tubular Water Tank 12 Lt. for VOLVO FH4

Tanica Acqua a Tubo Inox BA 12 Lt. per VOLVO FH4

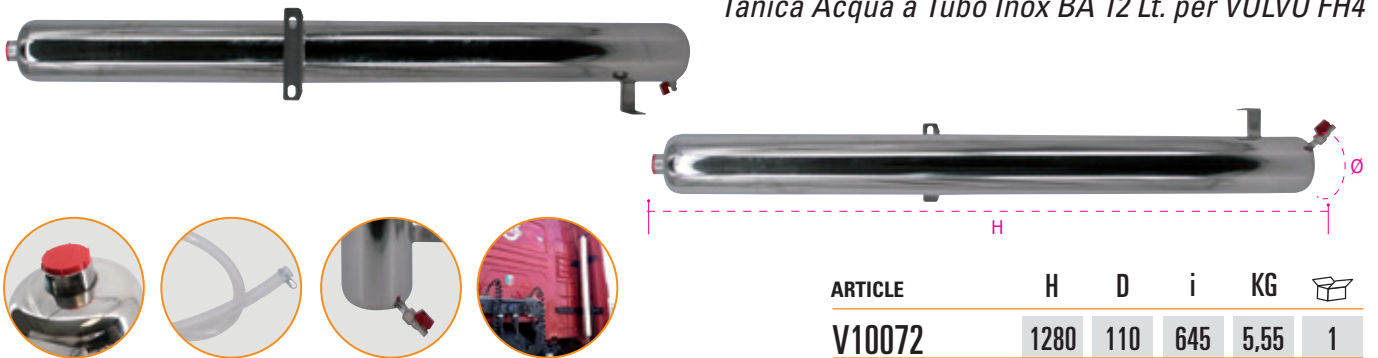

ARTICLE	H	D	i	KG	
V10072	1280	110	645	5,55	1

Stainless Steel BA Tubular Water Tank 12 Lt. for DAF XF 106

Tanica Acqua a Tubo Inox BA 12 Lt. per DAF XF 106

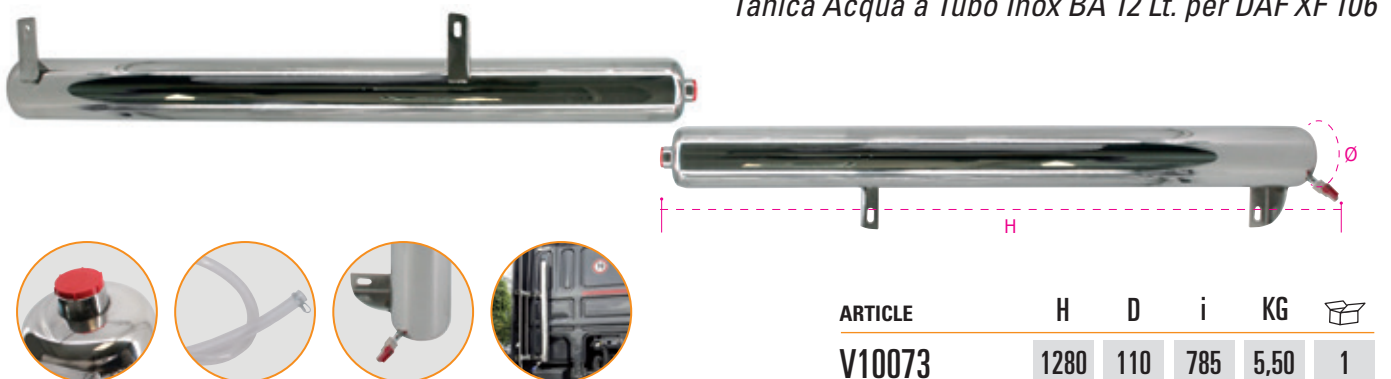

ARTICLE	H	D	i	KG	
V10073	1280	110	785	5,50	1

Stainless Steel BA Tubular Water Tank 12 Lt. for MERCEDES MP4

Tanica Acqua a Tubo Inox BA 12 Lt. per MERCEDES MP4

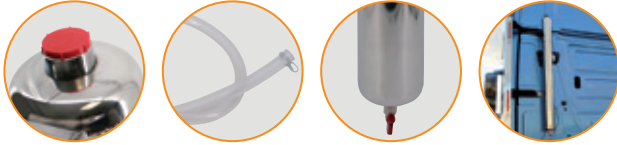
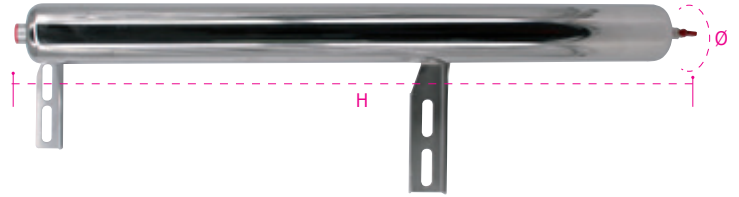

ARTICLE	H	D	i	KG	
V10074	1280	110	785	6,75	1

Stainless Steel BA Tubular Water Tank 12 Lt. for MAN E6 - TGX

Tanica Acqua a Tubo Inox BA 12 Lt. per MAN E6 - TGX

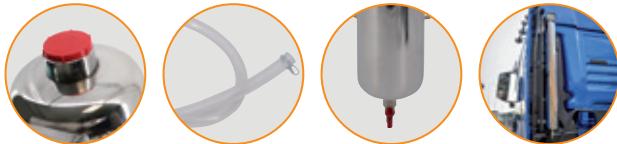
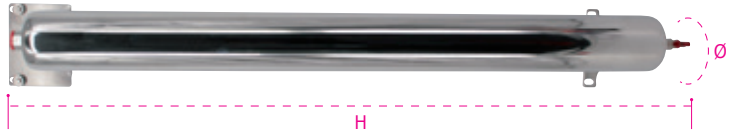

ARTICLE	H	D	i	KG	
V10075	1280	110	1250	6,50	1

Stainless Steel BA Tubular Water Tank 12 Lt. for RENAULT T

Tanica Acqua a Tubo Inox BA 12 Lt. per RENAULT T

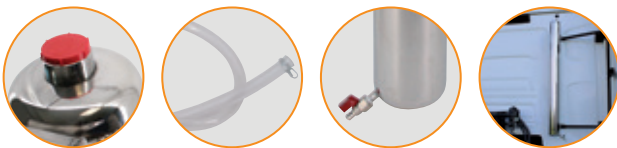

ARTICLE	H	D	i	KG	
V10076	1280	110	965	5,55	1

Stainless Steel BA Tubular Water Tank 12 Lt. for IVECO HI-WAY

Tanica Acqua a Tubo Inox BA 12 Lt. per IVECO HI-WAY

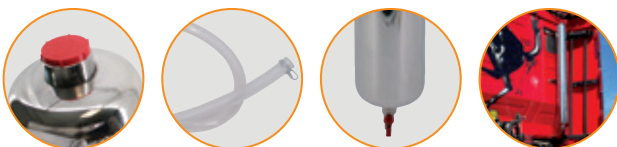
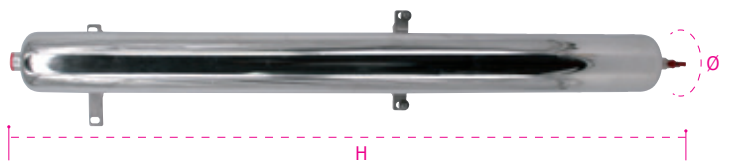

ARTICLE	H	D	i	KG	
V10077	1280	110	640	6,70	1

Stainless Steel BA Tubular Water Tank 12 Lt. for IVECO S-WAY

Tanica Acqua a Tubo Inox BA 12 Lt. per IVECO S-WAY

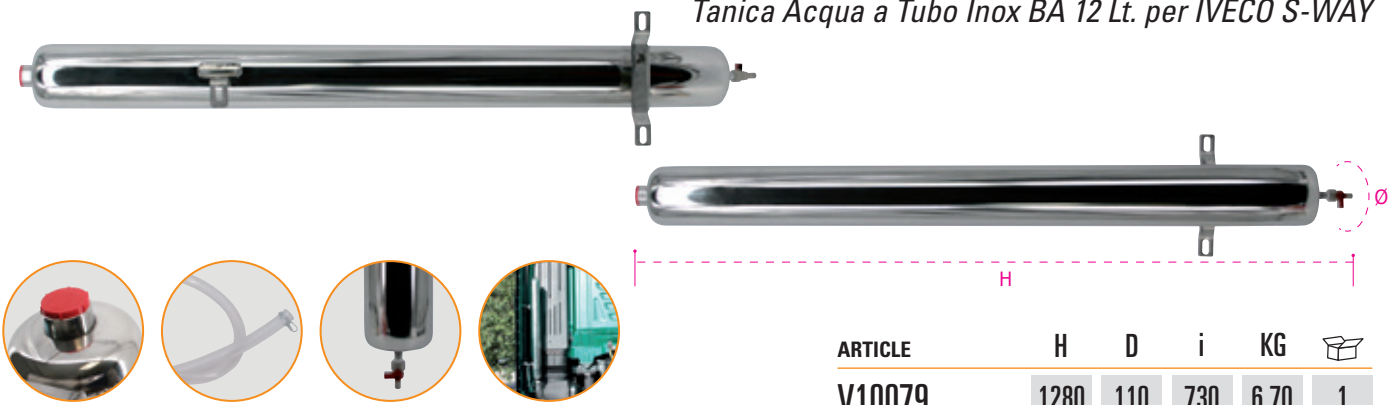

ARTICLE	H	D	i	KG	
V10079	1280	110	730	6,70	1

Stainless Steel BA Tubular Water Tank 12 Lt. for MAN TGX 2021>

Tanica Acqua a Tubo Inox BA 12 Lt. per MAN TGX 2021>

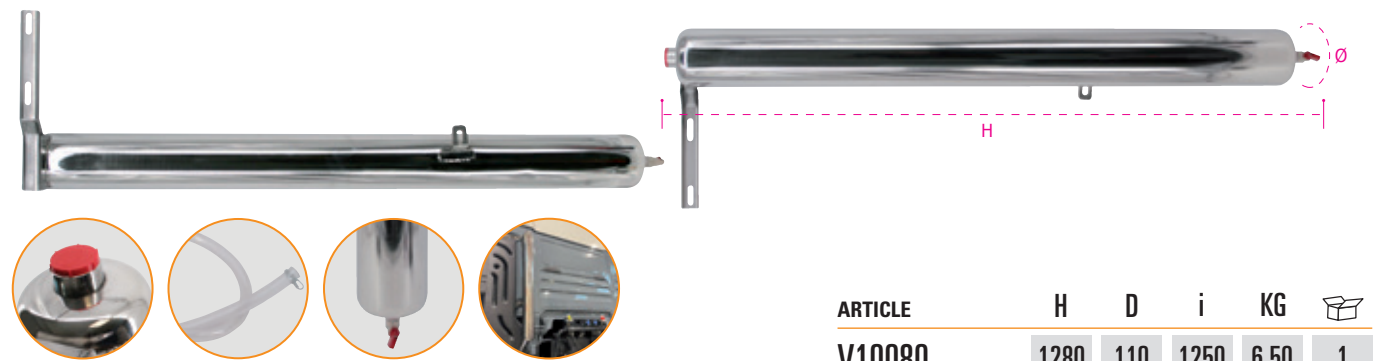

ARTICLE	H	D	i	KG	
V10080	1280	110	1250	6,50	1

Stainless Steel BA Tubular Water Tank 12 Lt. for DAF XF - XG - XG+

Tanica Acqua a Tubo Inox BA 12 Lt. per DAF XF - XG - XG+

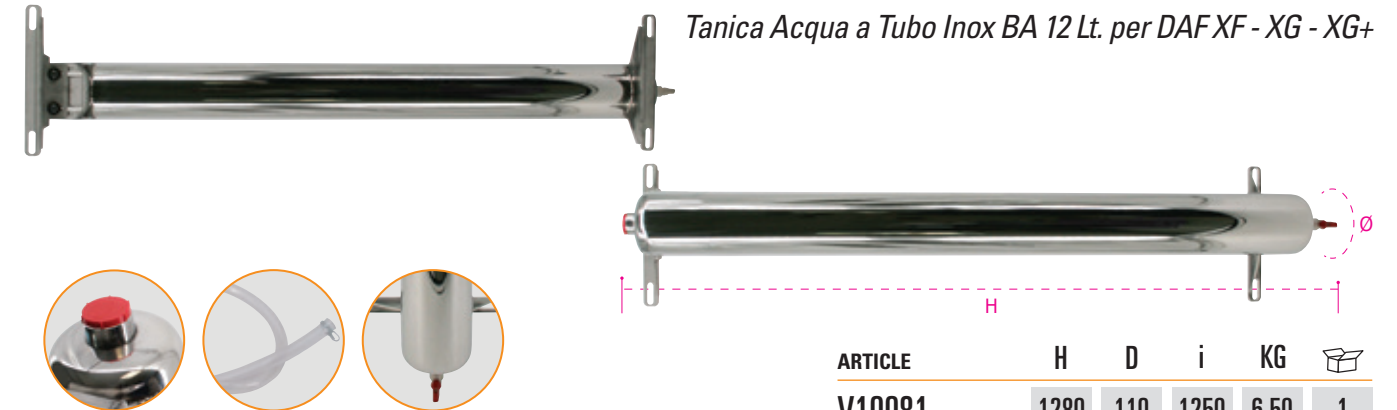

ARTICLE	H	D	i	KG	
V10081	1280	110	1250	6,50	1

Stainless Steel BA Tubular Water Tank 12 Lt. for FORD F-MAX

Tanica Acqua a Tubo Inox BA 12Lt. per FORD F-MAX

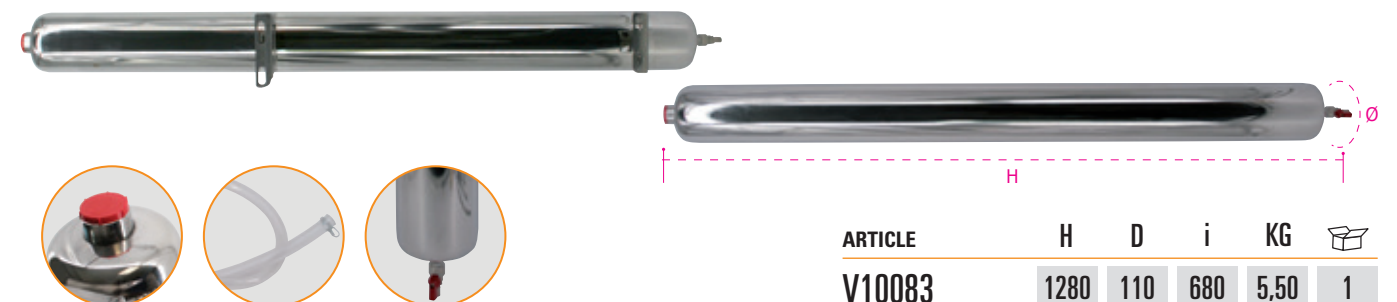

ARTICLE	H	D	i	KG	
V10083	1280	110	680	5,50	1

Flowered Stainless Steel Recovery Tank for Sewage 10 Lt. with Inox Inspection

Tanica Acciaio Inox Fiorettato Recupero Liquami 10 Lt. con Ispezione Inox

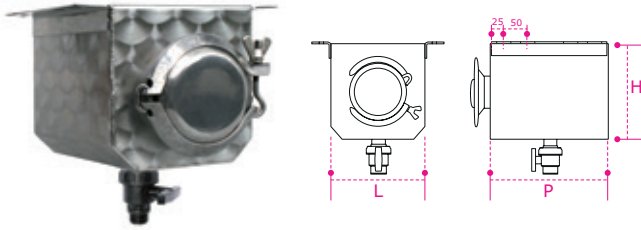

ARTICLE	L	H	P	SP	KG	
070002/I	200	200	250	15/10	5,10	1

TKcertRINA UNI EN ISO 15614-1:2012

Continuous support brackets. *Staffe supporto continue.*



Flowered Stainless Steel Recovery Tank for Sewage 18 Lt. with Inox Inspection

Tanica Acciaio Inox Fiorettato Recupero Liquami 18 Lt. con Ispezione Inox

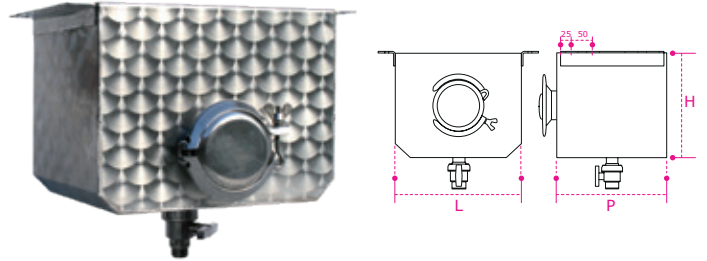

ARTICLE	L	H	P	SP	KG	
070001/I	300	250	250	15/10	6,85	1

TKcertRINA UNI EN ISO 15614-1:2012

Continuous support brackets. *Staffe supporto continue.*

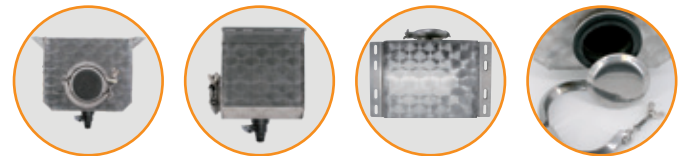

Flowered Stainless Steel Recovery Tank for Sewage 36 Lt. with Inox Inspection

Tanica Acciaio Inox Fiorettato Recupero Liquami 36 Lt. con Ispezione Inox



ARTICLE	L	H	P	SP	KG	
070010/I	400	300	300	15/10	9,60	1

TKcertRINA UNI EN ISO 15614-1:2012

Continuous support brackets. *Staffe supporto continue.*

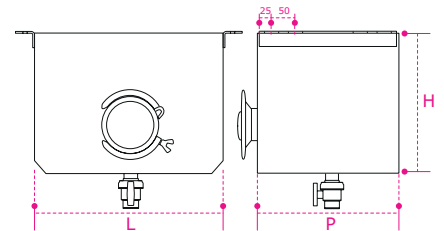
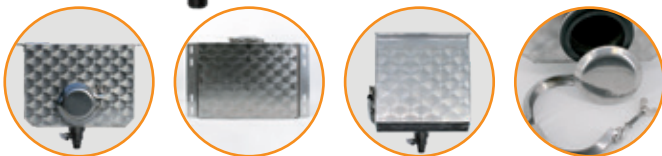

Flowered Stainless Steel Recovery Tank for Sewage 60 Lt. with Inox Inspection

Tanica Acciaio Inox Fiorettato Recupero Liquami 60 Lt. con Ispezione Inox

ARTICLE	L	H	P	SP	KG	
070011/I	600	250	400	15/10	13,50	1

TKcertRINA UNI EN ISO 15614-1:2012

Continuous support brackets. Ideal for Semi-trailers Lamberet Model. *Staffe supporto continue. Ideale per Semirimorchi Mod. Lamberet.*

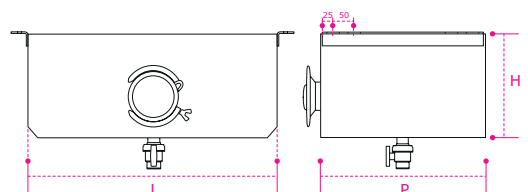

Flowered Stainless Steel Recovery Tank for Sewage with PVC Inspection

Tanica Recupero Liquami con Ispezione Pvc

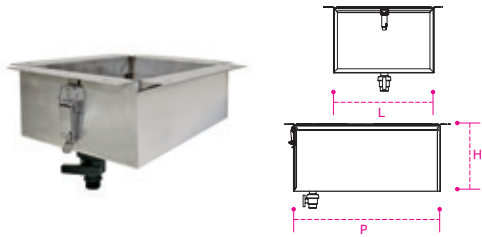

ARTICLE	LT	L	H	P	SP	KG	
V10041	2,5	150	80	210	10/10	1,10	1

i Drain valve included in the kit but not installed.
Valvola di drenaggio inclusa ma non installata.

Flowered Stainless Steel Recovery Tank for Sewage with PVC Inspection

Tanica Recupero Liquami con Ispezione Pvc

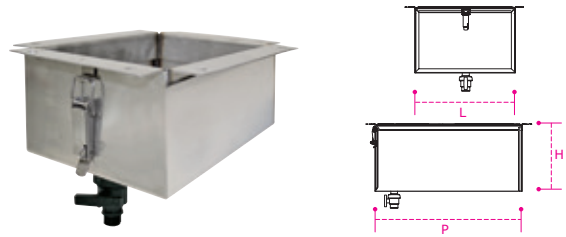

ARTICLE	LT	L	H	P	SP	KG	
V10042	13,5	210	210	310	10/10	2,40	1

i Drain valve included in the kit but not installed.
Valvola di drenaggio inclusa ma non installata.

Flowered Stainless Steel Recovery Tank for Sewage with PVC Inspection

Tanica Recupero Liquami con Ispezione Pvc

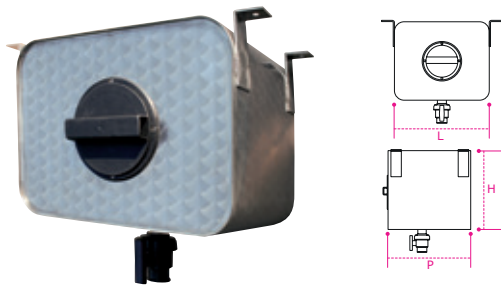

ARTICLE	LT	L	H	P	SP	KG	
070001	18	300	250	250	8/10	4,00	1
070010	34	390	290	300	8/10	7,90	1

Fiberglass Recovery Tank 7 Lt. for Sewage with Pvc Inspection

Vaschetta Recupero Liquami in Vetroresina con Ispezione PVC

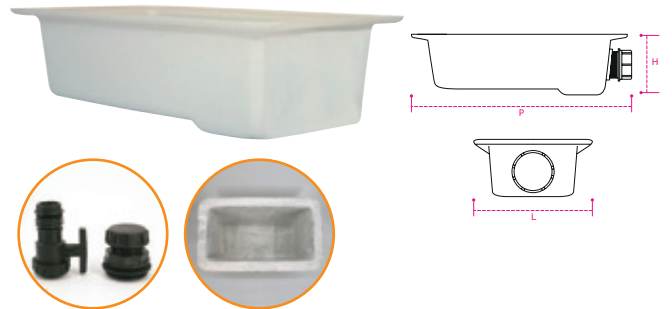

ARTICLE	LT	L	H	P	SP	KG	
V10048SL	7	240	110	400	40/10	1,30	1

i Drain valve included in the kit but not installed.
Valvola di drenaggio inclusa ma non installata.

"Small" Fiberglass Sewage Recovery Tank

Vaschetta Recupero Liquami in Vetroresina "Piccola"

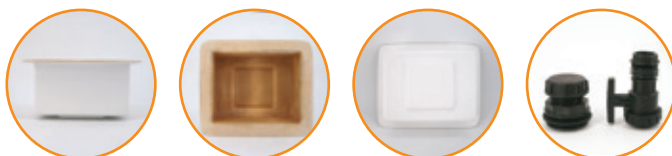

ARTICLE	LT	L	H	P	SP	KG	
V10048SP	2,4	225	115	185	50/10	0,45	1

i Drain valve included in the kit but not installed.
Valvola di drenaggio inclusa ma non installata.

"Big" Fiberglass Sewage Recovery Tank

Vaschetta Recupero Liquami in Vetroresina "Grande"

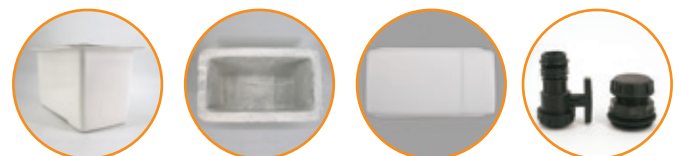

ARTICLE	LT	L	H	P	SP	KG	
V10048XL	12	400	220	240	70/10	1,20	1

i Drain valve included in the kit but not installed.
Valvola di drenaggio inclusa ma non installata.

Anti-theft Cap for Water Tank with Double Keys

Tappo Antifurto per Tanica Acqua con Doppia Chiave

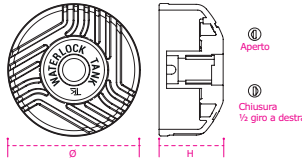

ARTICLE	H	D	KG	
111P	36	74	0,124	1

Assembly sheet supplied inside the box.
Lo schema di montaggio è fornito all'interno della scatola.

PVC Cap

Tappo PVC

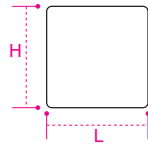

ARTICLE	L	H	KG	
110318202N	40	40	0,01	1
110318302N	50	50	0,01	1
ILR50X25	50	25	0,01	1
ILR30X15	30	15	0,01	1

Padlock

Lucchetto



ARTICLE	L	H	KG	
R60102	25	15	0,06	1

PVC Faucet

Rubinetto PVC Recupero Liquami



ARTICLE	L	H	KG	
V20016	70	105	0,07	1

Faucet 1/4

Rubinetto Dritto Passo 1/4



ARTICLE	PA	L	D	KG	
V20018	1/4	45	11	0,06	1

PVC Faucet for Water Tank 30 Lt.

Rubinetto Tanica 30 Lt.

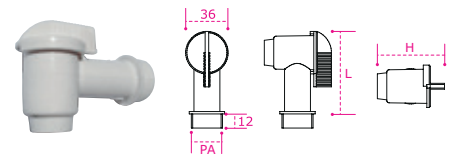

ARTICLE	L	H	PA	KG	
V20013	70	57	3/4	0,02	1

Pvc Cap

Tappo Tanica



ARTICLE	D	KG	
V20014	60	0,03	1

Inspection Cap

Tappo Ispezione



ARTICLE	D	KG	
V20015	140	0,08	1

PVC Cap

Tappo PVC



ARTICLE	H	D	KG	
111	30	60	0,017	1

26
TANICHE

TRUCK

Montepulciano Stazione (SI)

ITALY

+39.0578.708.709

info@truckspa.it